

FULL EXTENSION SYNCHRONIZED PUSH OPEN AND SOFT CLOSING UNDERMOUNTED SLIDE WITH LOCK (18MM)

Load capacity: 35Kg
 Length: 300–550mm
 Drawer height adjustment: 0~+3mm
 Drawer width adjustment: ±1.5mm

Installation dimensions(mm)
 SKW= Internal drawer width
 LW= Internal cabinet width (LW≥300mm)

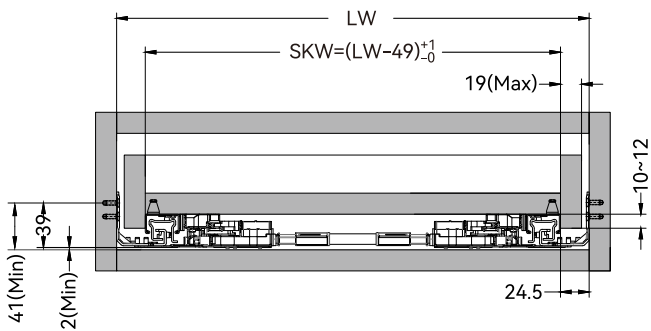

Hole positions(mm)

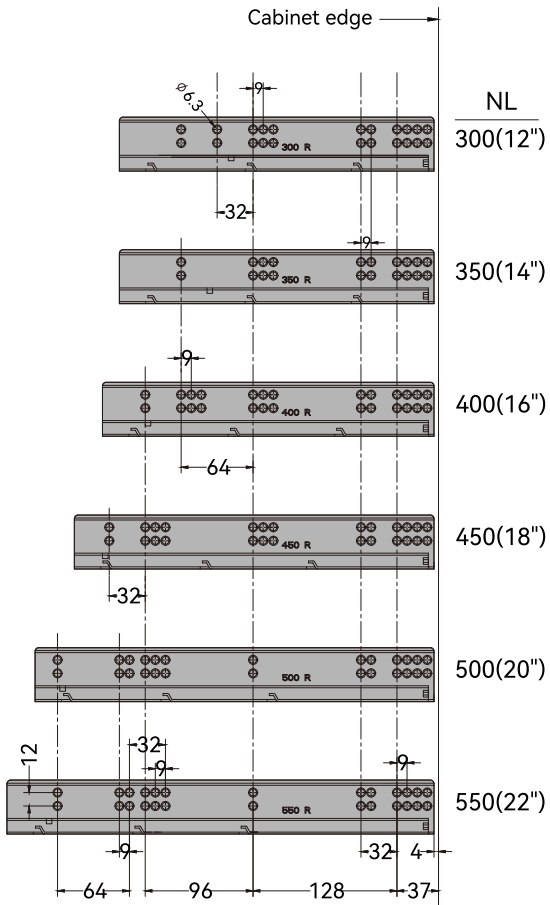

Installation dimensions(mm)
 NL= Nominal Length
 LT= Internal cabinet depth
 X= Front panel thickness

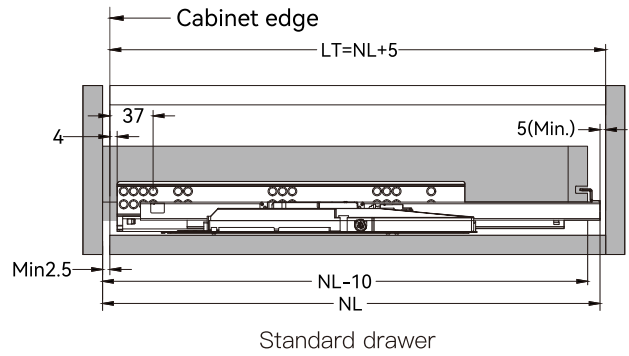

Standard drawer

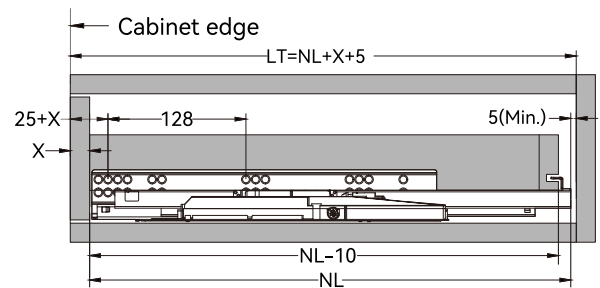

Internal drawer

Drawer size and drilling(mm)

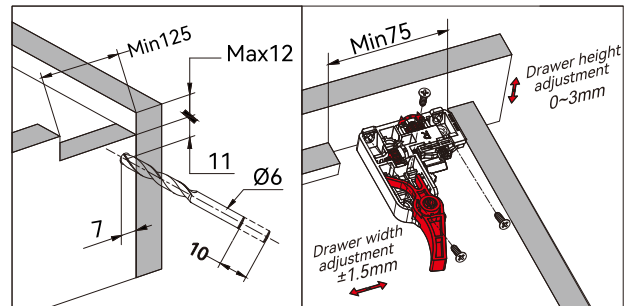

Installation steps for stabilizer bar

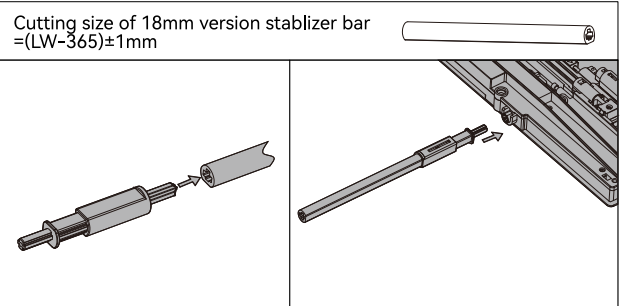

Front panel gap adjustment(+4~-2mm)

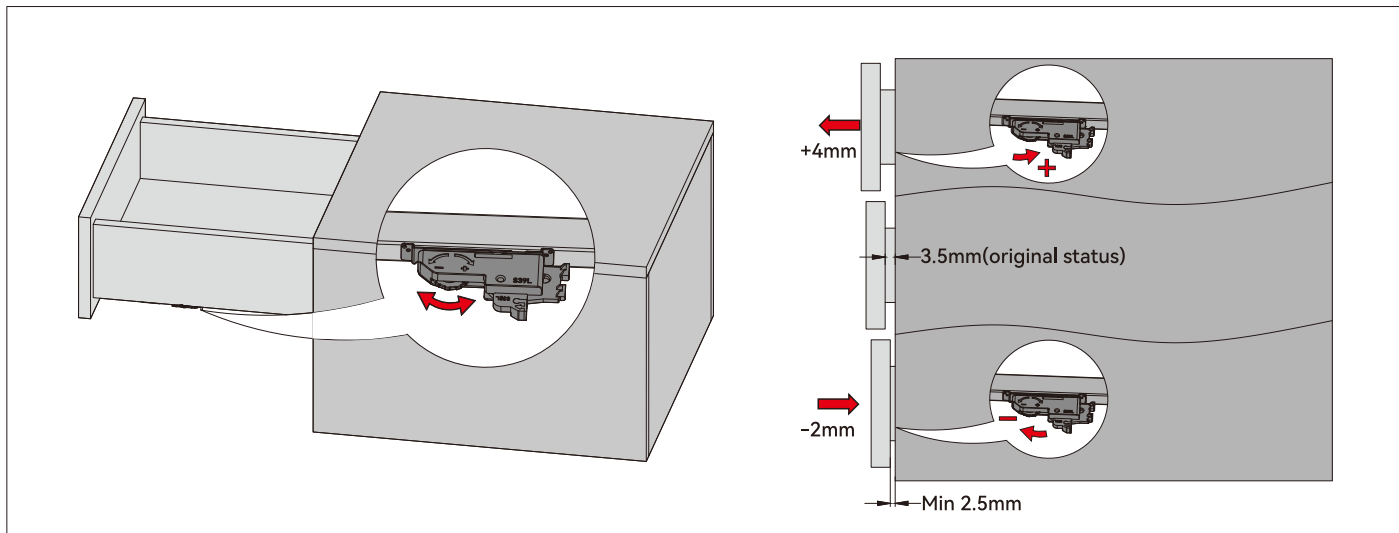

Suggested touching range

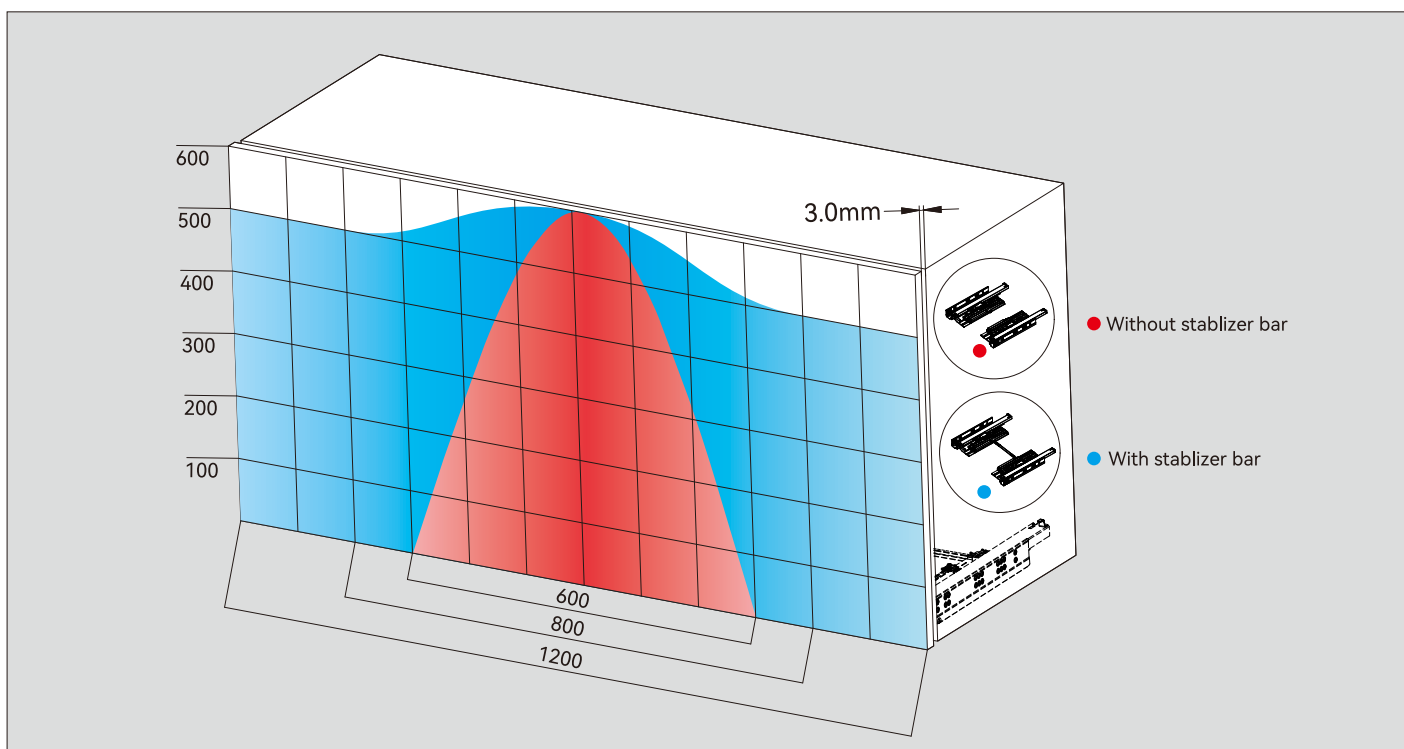

Installation of accessories

